



INTELLIGENT DEVICES FOR HANDLING



GROUP
Scaglia
1938

INDEVA[®]

INTELLIGENT DEVICES FOR HANDLING

Scaglia Indeva

A worldwide network at your service



A reliable Company with a long history

The ant is a tireless and intelligent worker. It is able to lift and carry with ease loads much larger than itself. This simple analogy represents Scaglia Indeva's mission to design and produce industrial manipulators that are compact yet strong, simple yet intelligent, and offer improved performance whilst reducing the risk of injury and improving workforce wellbeing.



A world-leading manufacturing company in the field of material handling and intra-logistics.

Since 1838 this family-owned company has been at the forefront of manufacturing and is now an important industrial group with diverse business interests worldwide.

Since 1970 Scaglia Indeva has been at the leading edge of design and manufacture of innovative, ergonomically designed industrial manipulators that are used by major global manufacturers in varied applications throughout the world.

World-wide, Scaglia Indeva works with many blue-chip manufacturers across most sectors, including the leading automotive companies, where innovative and reliable material handling solutions are required. Our headquarters are in Val Brembilla - Italy. Our key locations offer a central sales and support operation, which provides excellent engineering services and supply of spare parts.

HEADQUARTERS & PRODUCTION UNIT

ITALY



GERMANY



FRANCE



UNITED STATES



P.R. OF CHINA



UNITED KINGDOM



SWEDEN





References

ABB
 AIRBUS
 AKZO FIBERS
 APRILIA
 ARCELOR MITTAL
 AUDI
 B.P. CHEMICALS
 BANK OF ENGLAND
 BANQUE DE FRANCE
 BARILLA
 BEKAERT
 BENTELER
 BENTLEY
 BMW
 BORG WARNER
 BOSCH
 BREMBO
 BRIDGESTONE FIRESTONE
 BRITISH AMERICAN TOBACCO
 CATERPILLAR
 CHRYSLER
 CIBA GEIGY
 CITROËN
 COCA COLA
 COMAU
 CONTINENTAL
 CPM-DÜRR GROUP
 DAIKIN



DAIMLER
 DENSO
 DUCATI
 DUNLOP
 ELECTROLUX
 ENICHEM
 FAURECIA
 FCA
 FERRARI
 FERRERO
 FIAT
 FINMECCANICA
 FORD
 FRESENIUS
 GE AUTOMATION
 GE AVIATION

GENERAL ELECTRIC
 GENERAL MOTORS
 GLAXO
 GOODYEAR
 ITALTEL
 IVECO
 JAGUAR LAND ROVER
 JOHN DEERE
 JOHNSON & JOHNSON
 JSB
 KELLOGGS
 KIMBERLY CLARK
 KRAFT GENERAL FOODS
 KUKA
 LAMBORGHINI
 LEAR
 LEONARDO HELICOPTERS
 MAGNA WERKZEUGTECHNIK
 MAHLE
 MAN ROLAND DRUCKMASCHINEN
 MERCEDES BENZ
 MICHELIN
 MOËT & CHANDON
 NESTLE'
 NISSAN
 OPEL
 PEPSICO
 PERFETTI

PEUGEOT
 PHILIP MORRIS
 PIAGGIO
 PIRELLI
 PPG
 PROCTER & GAMBLE
 PSA
 RENAULT
 REYNOLDS TOBACCO
 ROLLS-ROYCE
 SAAB
 SAINT GOBAIN
 SCANIA
 SCHNEIDER ELECTRIC
 SIEMENS
 STILL
 TENARIS
 THYSSEN
 TOGG
 TOYOTA
 UNIFI
 UNIROYAL
 VALEO
 VOLKSWAGEN
 VOLVO
 WHIRLPOOL
 ZF



Scaglia Indeva

Intelligent Material Handling Technology

The Liftronic® Series, known as INDEVA® is a new generation of advanced industrial manipulators featuring electronic control. They represent the evolution from traditional manipulators and are part of the innovative product group of load handling devices known as **Intelligent Assist Devices**.

This series is equipped with an **advanced electronic control system** which overcomes the control limitations of pneumatic manipulators. They provide truly ergonomic and effortless handling.

The INDEVA® Liftronic® series offers numerous **important and unique advantages over a traditional pneumatic manipulator**, especially the **auto-weight sense and auto balancing** features:

- **Higher productivity:** using an INDEVA®, output can be maintained throughout a full shift giving increased productivity and operator wellbeing.
- **Better ergonomics:** a fingertip-sensitive handle allows for the lifting or lowering of heavy loads by simply touching the handle with a finger. Very little human effort is required during any part of the lift, place and lower process.
- **Higher precision:** with considerably more speed and precision than a traditional pneumatic manipulator, an INDEVA® allows for unsurpassed precision, where the operator will intuitively work at the pace best suited to the task. The operator has exceptional control with the lightest of touch needed.
- **User friendly:** the **auto weight sensing** and auto **balancing** functions operate in real time, so no need to pre-set the load or to keep buttons depressed. The **Float Mode** option allows the operator to control movement directly from the load.
- **Safety:** state-of-the-art safety features prevent movement unless an operator is present and in control. Should a power failure occur, the motor is held with a mechanical lock and the load cannot be released until power is restored, or the full weight of the load is supported.
- **Wireless connectivity for industry 4.0:** an INDEVA® can exchange data with the Customer IT System through the Company Network and allows visualisation of manipulator activity by means of interface software.
- **Remote trouble shooting:** an INDEVA® can be connected via Wi-Fi to **App Indeva**, so that machine data can be transferred to a remote tablet or smartphone in real time. This can assist fault diagnosis, so significantly reducing call-out charges and operator downtime.
- **Environment friendly:** low carbon foot print thanks to efficient and low energy consumption.

In applications which require speed of handling, smooth movement and precise load placement, the INDEVAs Liftronic® Series provide a perfect solution.



A recent case study by the Engineering Faculty of the Brescia University and published by the International Journal of Industrial Ergonomics, together with a comparison study carried out by the University of Milan proved how the use of an INDEVA® satisfies current industry demand for increased productivity combined with improved ergonomics and safety.





EASY MAINTENANCE

Optimised modular structure with easy access to all components.

Z AXIS CONTROL

It is possible to limit the stroke on the Z axis to suit the specific restrictions of each application.

QUICK DIAGNOSTIC

Comprehensive auto - diagnostic software with clearly displayed error messages.

TOUCH PANEL

User friendly and intuitive interface for the visualisation and setting of various operational parameters.

FORCE SENSING HANDLE

It allows fingertip control providing immediate response to the operator's intention for up-down movements.

STATE-OF-THE-ART SAFETY DEVICES

Electronic control allows for additional safety functions that cannot be incorporated in pneumatic manipulators.

WIRELESS CONNECTIVITY AND REMOTE TROUBLE SHOOTING

Industry 4.0 ready.

EASY TO UPGRADE

Designed to accept controls for your own gripping tools.

ANTI-TANGLE- SWIVEL JOINT

Air and electrical connections are via a swivel joint on top of the tool head. This prevents the lift rope, power cable and air pipe becoming tangled if the process has continuous rotation in the same direction.

FINE SPEED CONTROL

An INDEVA® moves at the pace best suited to the operator and application. This allows natural movement at all times, especially where precise placement is required. It is also possible to limit the lift and lower speed via the control panel.

CAPACITY OVERLOAD

The maximum permitted lift can be preset to prevent system overload.

FLOAT MODE

This control mode allows the operator to manipulate the load without direct contact with the controls.

LOAD PLACEMENT PRECISION

The system allows very slow and controlled movements, so that a load can be precisely placed with no impact, so reducing the risk of damage.

Scaglia Indeva

Manipulators range

Liftronic® Series

Intelligent
Devices for
Handling

Electronic control

The Liftronic® Series Intelligent Devices for Handling, known as INDEVA®, represent true evolution of traditional industrial manipulators.

State-of-the-art standardised components, combined with cutting-edge technology, hardware and optimised software provide a **high degree of safety and reliability.**

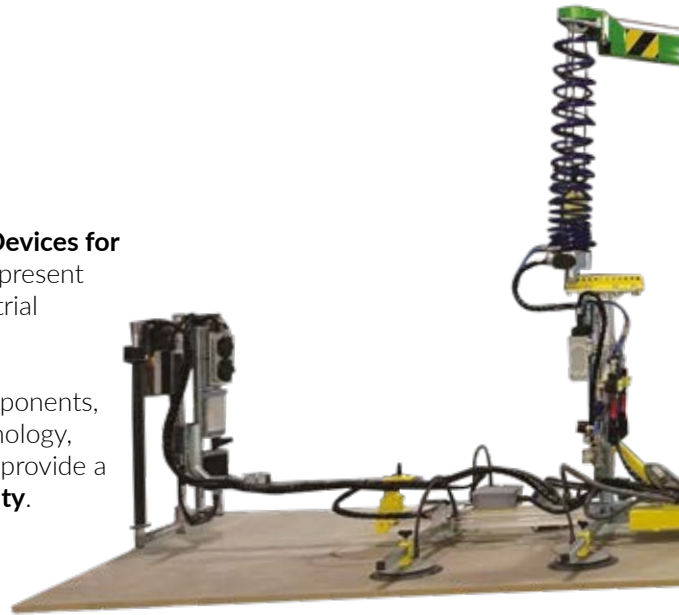

Automatic weight sensing in real time.

Automatic weight balancing in real time allowing variable weights to be handled without presetting load.

Moves as fast or as slow as the operator decides using fingertip control with minimal effort and instant response.

AUTO-WEIGHT
SENSE

AUTO
BALANCING

RESPONSIVENESS

No weight sensing.

Weight balancing is not automatic or real time. Pre-set weights via selector switch.

System response is slower and feels heavier because of this, especially with upward movement.

PN Series

Traditional
Industrial
Manipulators

Pneumatic control

PN series manipulators are traditional industrial manipulators featuring pneumatic control and drive.

All manipulators in the PN Series can be designed in accordance with **ATEX regulations** as per EU Directives 2014/34 regarding applications in controlled environments with danger of explosion, classified classes 1 and 2 (Gas) (only for PN Flex) and 21 and 22 - Dust (for all PN series models).

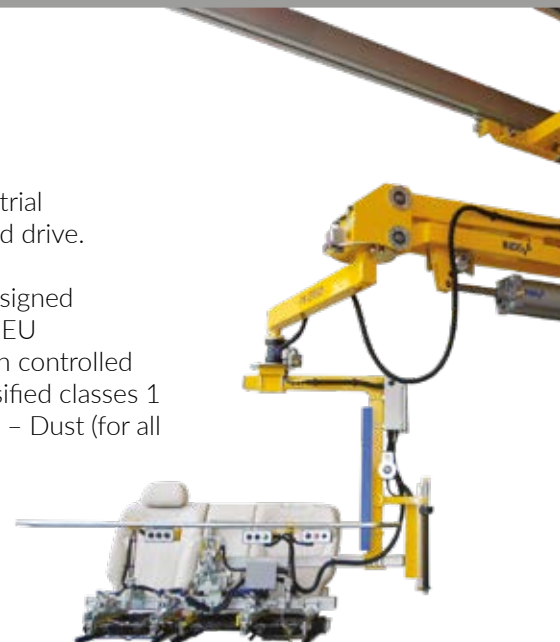



Rope

Liftronic® Easy

Capacity up to 320kg.
Suitable for **rapid and repetitive work cycles with simple gripping tools.**

Liftronic® Pro

Capacity up to 320kg.
Suitable for **complex work cycles with bespoke gripping systems.**



Rigid arm

Liftronic® Air

Capacity up to 570kg.
Suitable for handling **offset loads** with speed and precision.

Precise and coordinated with fine adjustment allowing accurate placement so reducing the risk of damage.

Lower: a comparative study showed that the CO² output and total running cost of an INDEVA® is around only 12,5% that of a pneumatic manipulator.

Light and compact structure allows **great visibility and ease of maneuverability.**

Comprehensive auto - diagnostic software and remote trouble shooting with App-Indeva or INDEVA® Gateway.

Simple and efficient: by means of display.

LOAD PLACEMENT

CARBON FOOTPRINT & TOTAL COST OF OPERATION

MANEUVERABILITY

DIAGNOSTIC & REMOTE TROUBLE SHOOTING

MAN/MACHINE INTERFACE

Some resistance is felt as air enters and leaves the cylinders so restricting natural speed of movement.

Higher: a comparative study showed that the CO² output and total running cost of a pneumatic manipulator is around 8 times that of an INDEVA®.

System requires heavier and bulkier structure so reducing visibility and maneuverability.

Check and diagnosis by expert technician attending site. Remote trouble shooting is **not available.**

Restricted options to identify faults at the machine.



Rope

PN Flex

Capacity up to 160kg.

PN Ergo

Capacity up to 570kg.
Suitable for handling **offset loads.**

Rigid arm

PN Compatto

Capacity up to 100kg.
Suitable for handling **offset loads in a small work area.**

PN Zip

Capacity up to 80kg.
Very compact structure suitable when a **short vertical stroke** is required.

Liftronic® Easy

Intelligent Device for Handling

Liftronic® Easy is an INDEVA® - Intelligent Device for Handling. Suitable for rapid and repetitive work cycles with **simple gripping tools**.

Main features

- Auto-weight sense and auto-balancing
- Can be integrated with App-Indeva and INDEVA® Gateway
- Unparalleled safety
- Ergonomic design
- Simple gripping devices
- Compact and light
- Fast, responsive and precise
- Low carbon footprint

INDEVA® Gripping tools



TECHNICAL DATA

Max. gross capacity: from 80 to 320kg
(weight of lifting tool included)
Power supply: 110/230 V-AC - 50/60 Hz
Power consumption: max 700 VA
Enclosure protection: 54 IP
Vertical stroke: up to 2.80m



INDEVA® Modulo

Make your own gripping tool

Liftronic® Series

INDEVA® Modulo is a standard component range for assembling a gripping tool which is to be attached to a Liftronic® Easy tool head. It is easy for customers to design the tool to best suit their needs and then purchase the necessary parts. These standardised modules have been proven over many years and are a key part of our continuous improvement and development program.

I-Connect



Standard I.O. Interface module; you can easily implement safety functions for your own custom gripping tool

Gripping Modules

These chucks can be fitted with jaws according to your specific requirements



Scissor pantograph

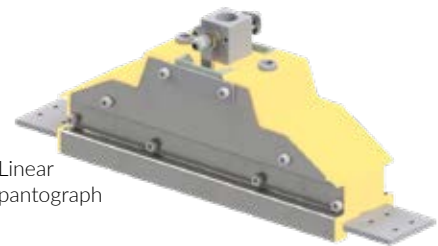

Linear pantograph



Machine/Operator Interfaces



Remote controls



Remote touch sensitive handle available in different lengths

Accessories



Air and electric connections via a continuous swivel joint at the toolhead to keep cables from tangling

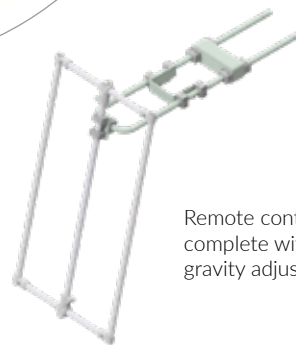

Remote control handles complete with centre of gravity adjustment

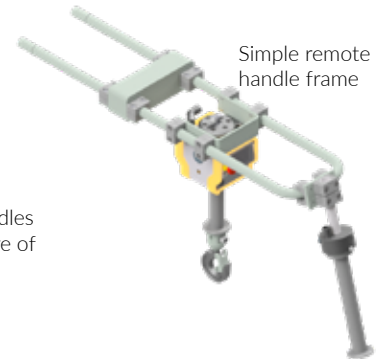

Simple remote handle frame



Liftronic® Pro

Intelligent Device for Handling

Liftronic® Pro is an INDEVA® - Intelligent Device for Handling.
It is used for **complex applications with bespoke gripping systems**.

Main features

- Auto-weight sense and auto-balancing
- Can be integrated with App-Indeva and INDEVA® Gateway
- Unparalleled safety
- Ergonomic design
- Bespoke gripping devices
- Compact and light
- Fast, responsive and precise
- Low carbon footprint



CUSTOMER
IT
SYSTEM

WI-FI COMPANY
NETWORK

INDEVA® Gripping tools



TECHNICAL DATA

Max. gross capacity: from 80 to 320kg
(weight of lifting tool included)
Power supply: 110/230 V-AC - 50/60 Hz
Power consumption: max 700 VA
Vertical stroke: up to 2.80m

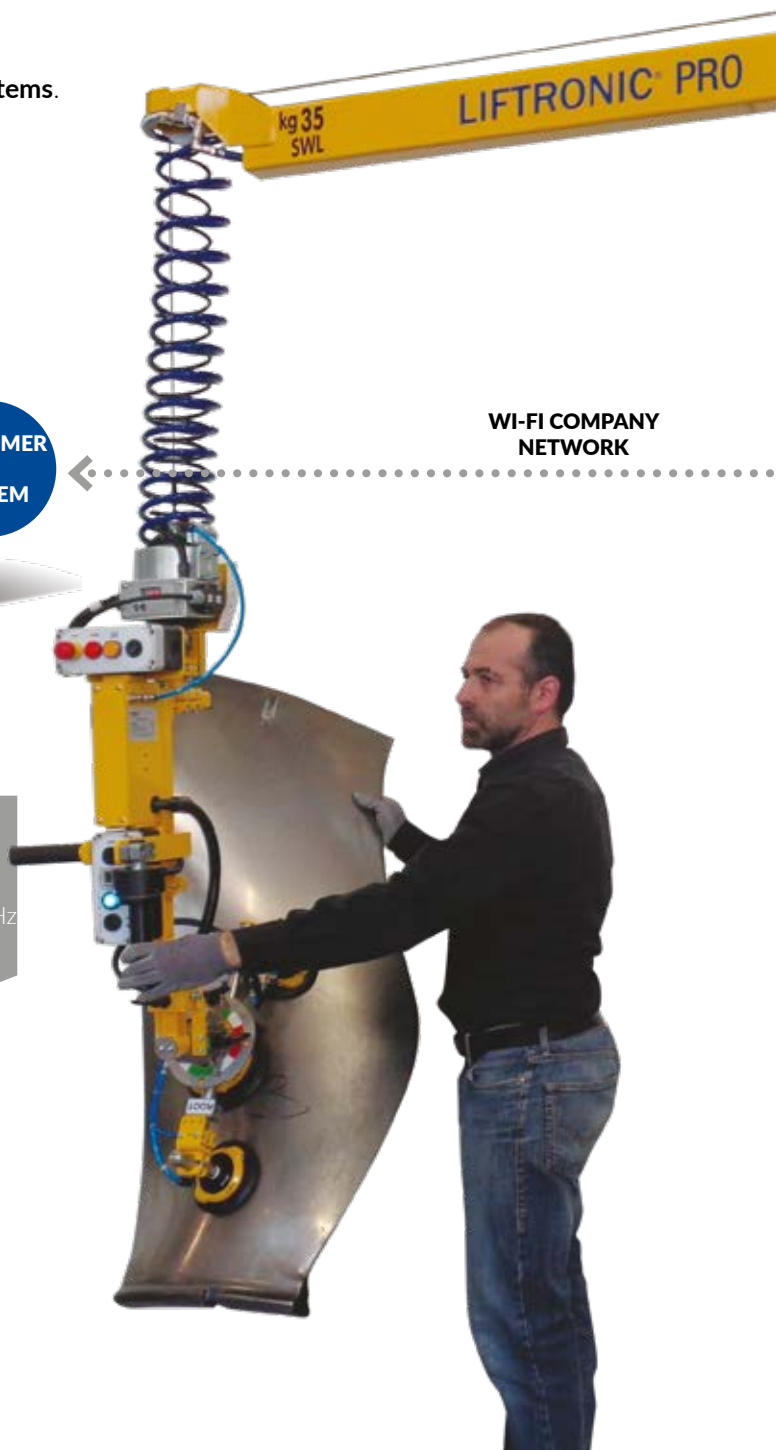

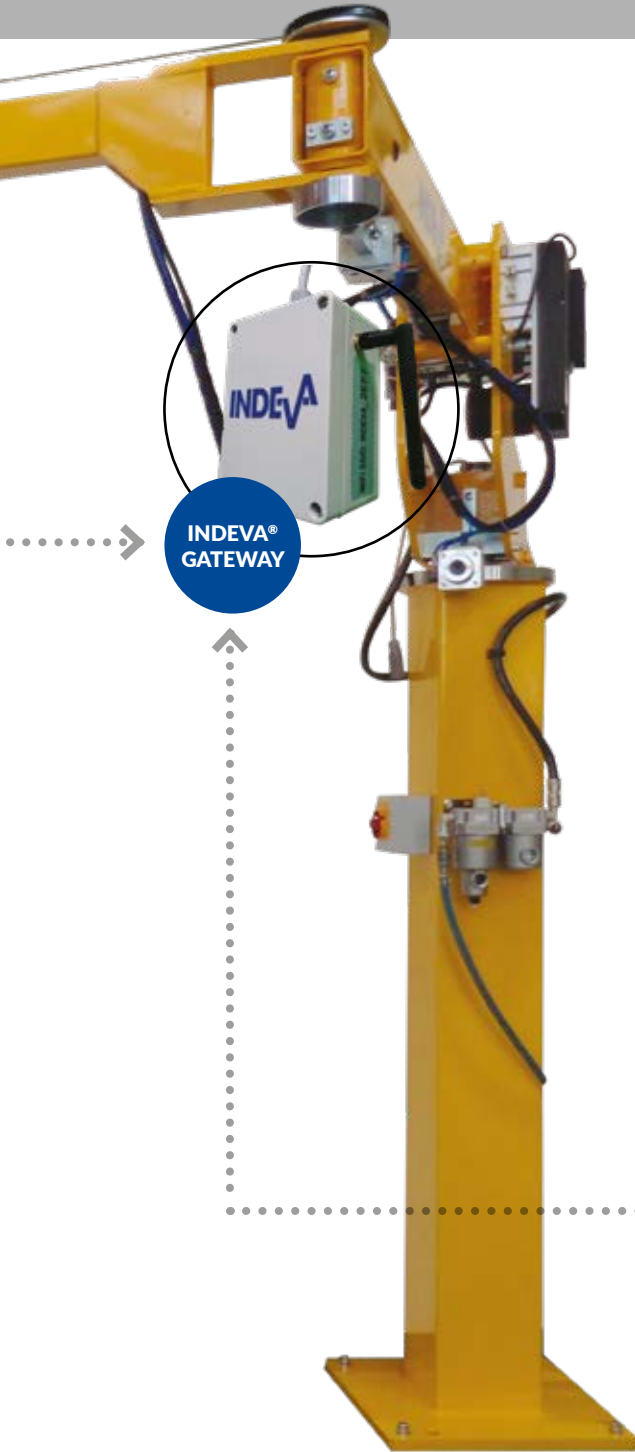

Industry 4.0 ready

App-Indeva

Is a virtual INDEVA® service engineer always at disposal to the INDEVA® technician providing machine data capture and analysis, diagnostic and real time trouble shooting.

App-Indeva, is based on an in-house designed App suitable for Android smartphone or tablet that can be connected via Wi-Fi to the lift assistor, features **real-time capability to collect and analyse machine data** and deliver the results to the INDEVA® technician and to a **remote Indeva Service Centre**.

If you are using an INDEVA® manipulator equipped **with App-Indeva you will increase your machine availability time** through:

- reduced time for diagnosis and trouble shooting by the INDEVA® technician
- reduced time for communication with an INDEVA® service centre

INDEVA® Gateway

Allows real time data exchange with the Customer IT System through the Company Wi-Fi network and allows visualisation of production data by means of an interface software.



APP-
INDEVA

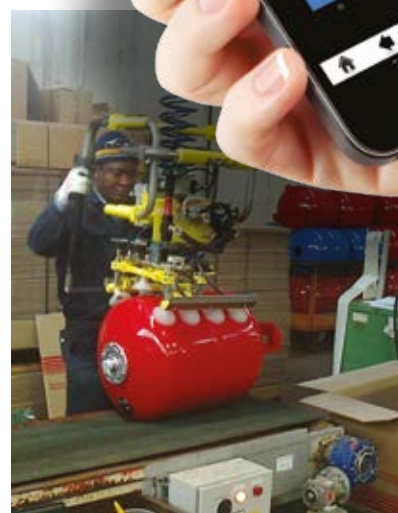

Liftronic® Pro & Easy Versions

Articulated Arms

2 JOINT ARMS

Standard arms featuring 2 joint articulation.

STRUCTURE	R1 (m)	2.5	3	3.5	4	4.5
L= Light	LC kg R2 (mm)	80 450	60 550	40 650	- -	- -
H= Heavy	LC kg R2 (mm)	260 630	190 760	140 880	105 1020	78 1140
X= Extra	LC kg R2 (mm)	- -	320 860	320 1005	280 1150	220 1300

LC= max load capacity; R2= dead area

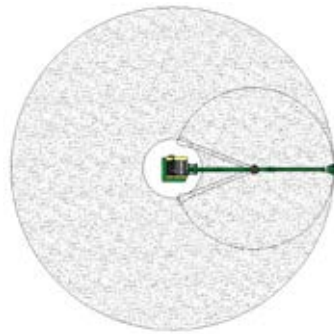
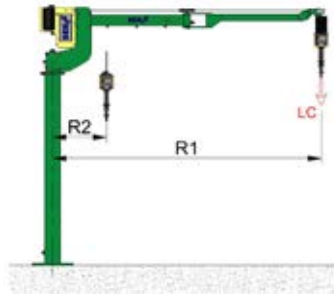

Column + arm



Fixed to floor



Fixed to a base platform

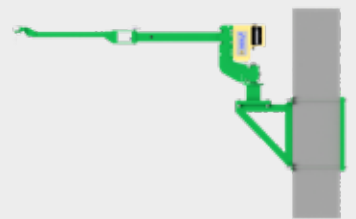

Fixed to a Pillar

3 JOINT ARMS

The INDEVA® Orbit Arm3 is a 3 joint arm available on request for both column and overhead versions with capacities up to 145 kg (including tooling). The 3 joint Arm provides **increased coverage** within the radius of the arm and offers the operator smooth, controllable movement across the full radius with the added benefit of **quick sideways movement** using the forearm only.

STRUCTURE	R1 (m)	2.75	3.25	3.75	4.25	4.5
L= Light	LC kg R2 (mm)	- -	- -	- -	- -	- -
H= Heavy	LC kg R2 (mm)	145 250	105 250	80 250	55 250	45 250
X= Extra	LC kg R2 (mm)	- -	- -	- -	- -	- -

LC= max load capacity; R2= dead area

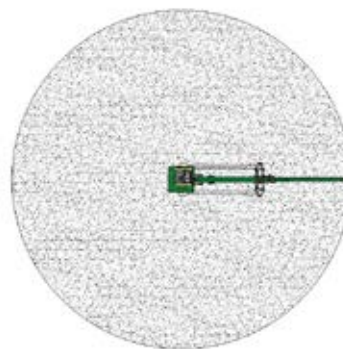
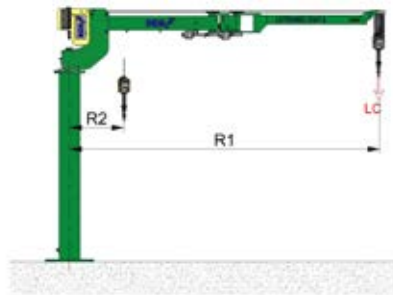

Overhead Arm



Fixed to ceiling

Liftruck

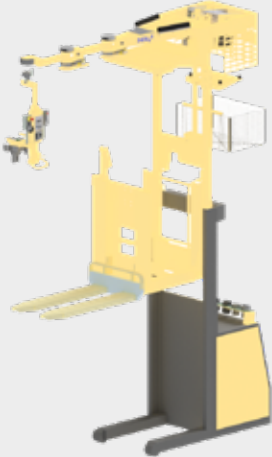

Order picker

Linear



Fixed to floor/base

Overhead rail

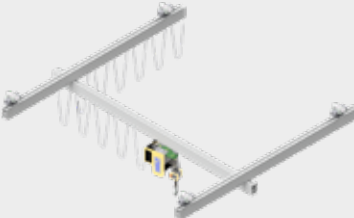

Bridge crane fixed to ceiling



Bridge crane column mounted



Underhung

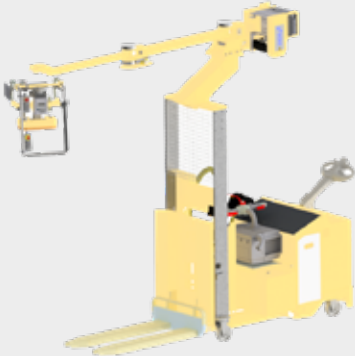

Transpallet



Underhung

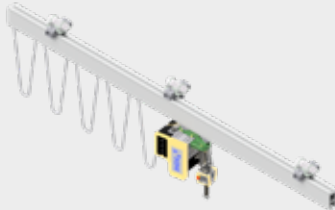

Monorail fixed to ceiling



Liftronic® Air

Intelligent Device for Handling

Pneumatic drive - electronic control

The world's first manipulator with the strength of a traditional pneumatic manipulator and the intelligence of an INDEVA®.

It offers electronically controlled air and load management, delivering precise, energy efficient handling and auto weight sensing, removing the responsibility from the operator to make adjustments for different weights by utilising our touch sensitive handle technology.

It is suitable for handling offset and/or very heavy loads with minimum effort.

Liftronic® Air units can be supplied either column, ceiling or overhead rail mounted.

Compared to traditional pneumatically controlled manipulators, Liftronic® Air offers important advantages which help **improve safety, ergonomics, productivity and the Environment.**

Main features

- Efficient use and delivery of air
- Auto-weight sense and auto-balancing
- Unparalleled safety
- Fast, responsive and precise
- **Low carbon footprint**



STANDARD MODELS		LIFTRONIC AIR						
		LA80		LA160		LA250		LA400
Gross capacity (including lifting tool)	kg	80	110*	160	210*	250	310*	400**
Vertical stroke	mm	1752	1752	1716	1716	1451	1451	1167
Arm length	mm	2700	2700	2700	2700	2605	2605	2000
Offset handling: max. distance from the lifting tool Z axis	mm	300	-	300	-	500	-	400
Uncovered area	mm	907	907	935	935	900	900	-
Rotation around column axis	degrees	360°						
Rotation around tool axis	degrees	550°						
Air pressure min.	bar	6.5						
Power supply	V-AC Hz	115/230 50/60						
Power consumption max	VA	100						
Enclosure protection	IP	54						

**Available in 5 versions with load capacities up to 570 kg.

*With counterweights.





PN Series

Traditional Industrial Manipulators

PN Series are traditional industrial manipulators featuring **full pneumatic operation**.

It is suitable for handling offset and/or very heavy loads.

PN units can be supplied either column, ceiling or overhead rail mounted.

Main features

- **Reliable**

Continuous product development using standard modules and components for improved safety and efficiency.

- **Safe**

Equipped with safety devices that maintain the grip on the load, even in the event of a total air loss.

It is not possible to release the load when it is fully supported by the machine. When the control handle is released, a full set of brakes lock the machine and prevent further movement

- **Versatile**

It can be equipped with a wide range of bespoke tools operated pneumatically by grip or vacuum. Simple mechanical tools can also be used.

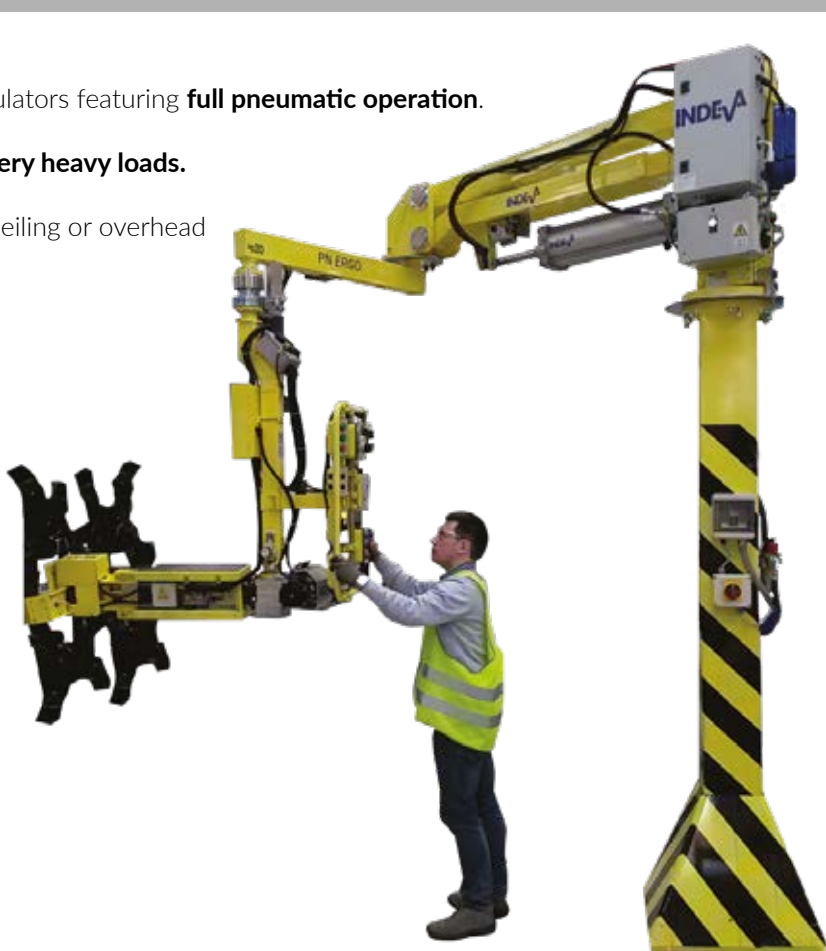

STANDARD MODELS		PN ERGO						
		PN80		PN160		PN250		PN400
Gross capacity (including lifting tool)	kg	80	110*	160	210*	250	310*	400**
Vertical stroke	mm	1752	1752	1716	1716	1451	1451	1167
Arm length	mm	2700	2700	2700	2700	2605	2605	2000
Offset handling: max. distance from the lifting tool Z axis	mm	300	-	400	-	500	-	400
Uncovered area	mm	907	907	935	935	900	900	-
Rotation around column axis	degrees	continuous						
Rotation around tool axis	degrees	standard: 550 optional: continuous						
Air pressure min.	bar	6.5						

**Available in 5 versions with load capacities up to 570 kg.

*With counterweights.



PN Series



PN Ergo



PN Compatto



PN Flex



PN Zip

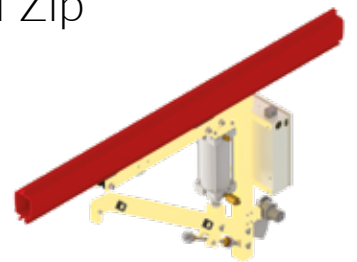

Industry fields

- AGRICULTURE
- AEROSPACE
- AUTOMOTIVE
- BATHROOM AND TOILETWARE
- CERAMIC
- CHEMICALS/ PHARMACEUTICALS
- ELECTRO-MECHANICAL
- ELECTRONICS
- FOOD/DRINK/TOBACCO
- FOUNDRY
- FURNITURE
- GLASS
- HOUSEHOLD ELECTRIC APPLIANCES
- MECHANICS
- METAL WIRES
- MOTORCYCLES
- PAPER PRODUCTION
- RUBBER/PLASTICS
- TEXTILE
- TYRES

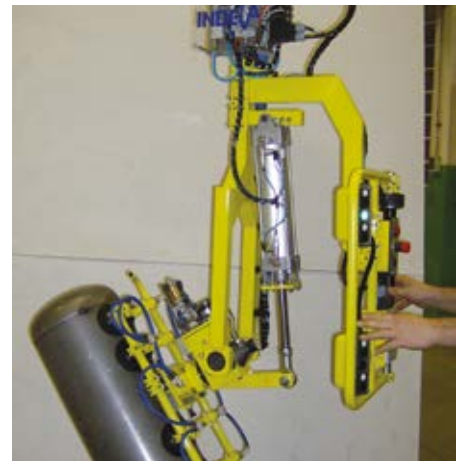
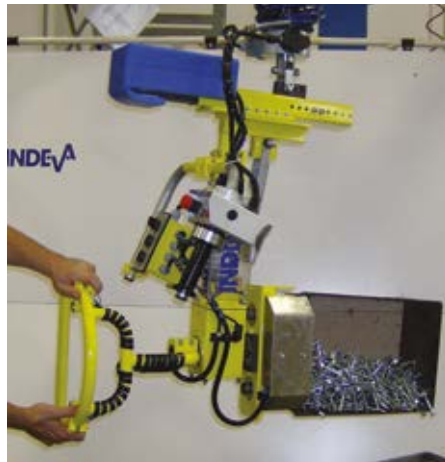





Scaglia INDEVA
Italy

Scaglia INDEVA SpA
Via Marconi, 42
24012 Val Brembilla (BG)
Tel. +39 0345 59 411
info@it.indevagroup.com
www.indevagroup.it



Scaglia INDEVA
Germany

Scaglia INDEVA GmbH
Esslinger Str. 26
D-73249 Wernau
Tel.+49 (0) 7153 55049-0
info@de.indevagroup.com
www.indevagroup.de



Scaglia INDEVA
France

Scaglia INDEVA SARL
215 Rue Henry Barbusse
95100 Argenteuil
Tel.: +33 (0) 1 39 19 30 30
info@fr.indevagroup.com
www.indevagroup.fr



Scaglia INDEVA
United Kingdom

Scaglia INDEVA Ltd
Coney Green Business Centre, Clay Cross
Chesterfield, Derbyshire S45 9JW
Tel. +44 (0) 1246 25 23 33
info@uk.indevagroup.com
www.indevagroup.co.uk



Scaglia INDEVA
Sweden

SCAGLIA INDEVA Nordic AB
Torbornavägen 24
253 68 Helsingborg
Tel. +46 (0) 424002460
info@se.indevagroup.com
www.indevagroup.se



Scaglia INDEVA
United States

Scaglia INDEVA Inc.
3630 Green Park Circle
Charlotte, NC 28217
Tel. +1 704 357 8811
info@us.indevagroup.com
www.indevagroup.com



Scaglia INDEVA
P. R. of China

INDEVA SHANGHAI LIMITED
Room 223,225,227, Block 9, No. 265, Putuo Road
Chuansha Town, Pudong New District, Shanghai 201202
Tel. +86 13816083244
info@cn.indevagroup.com
www.indevagroup.cn