



The latest  
**application  
strategies**

Toolpath optimisation  
Programming solutions  
Tooling choice  
Complete tooling packages



INFINITE POSSIBILITIES.<sup>®</sup>

# Ultimate profitability

Do you have a component that is taking too long to manufacture? Are you struggling to find the time and resources to investigate advanced machining and cutting tool strategies that could easily double your output? Yes? Then you need to put QuickCam to the test.

QuickCam is the advanced service from Quickgrind designed to support you with the machining of complex parts in difficult materials.

Implementing QuickCam in your business will give you reduced cycle times, leading to reduced tooling costs, increased output and improved capacity.

The bottom line? Improved throughput, more satisfied customers and increased profitability.

Contact us today to arrange  
your free initial assessment.

**t** +44 (0) 1684 294090

**e** [quickcam@quickgrind.com](mailto:quickcam@quickgrind.com)

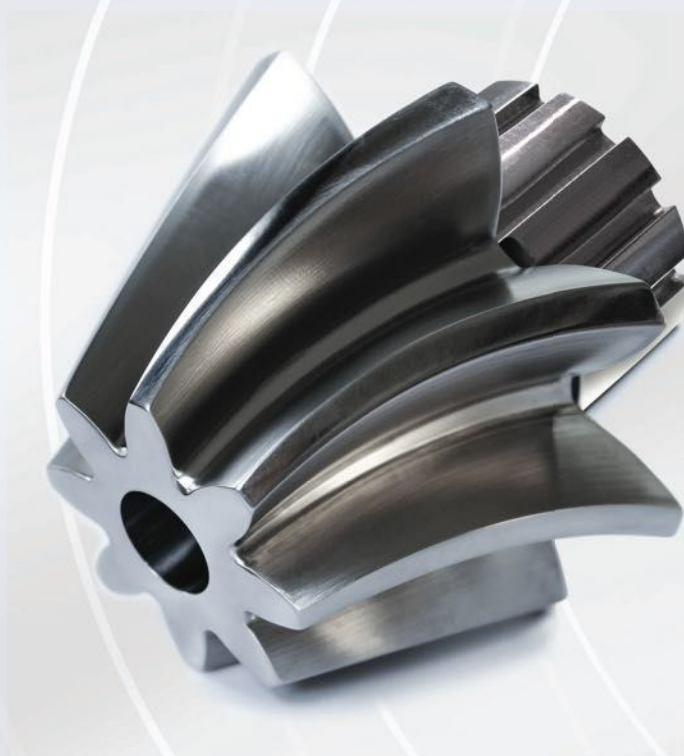
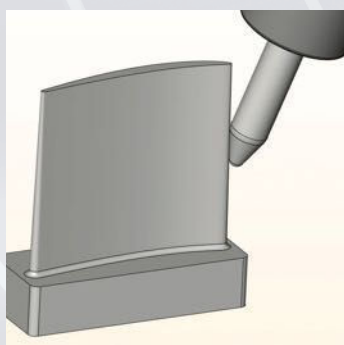
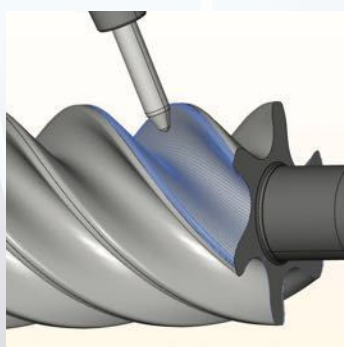
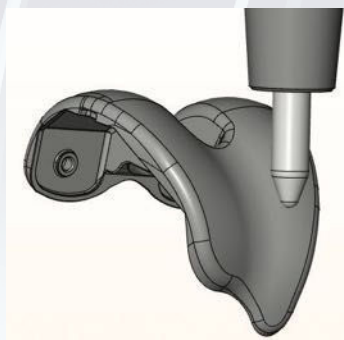

## Benefits

- Reduced cycle time costs
- Reduced tooling costs
- Increased output
- Improved capacity
- Increased profits

# Why choose QuickCam?

QuickCam offers performance enhancing strategies to best suit your parts and machines. A virtual meeting with one of our engineers will allow us to discuss your requirements as well as gather information on your machines, tooling and any existing strategies.

## How does it work?

Once you have decided to use the QuickCam service we will ask you to set-up an account with us as well as to sign an electronically generated NDA – this is to protect your IP rights when sending us your confidential model data.

We will need a copy of the 3D model you intend to use including any supporting documents. If required, fixture design can also be included.

## Toolpath optimisation

Quickgrind offers the very latest cutting-edge carbide tools. By using QuickCam in conjunction with machining cycles from *hyperMILL®*, our in-house CAM software, and CGTech VERICUT's tool path verification programmes, you know that your strategies are always going to be up-to-date.

Our state-of-the-art Technical Centre is the ideal environment in which to discover the latest machining methods. Using our Mazak 5-axis and Quaser 3-axis machining centres or virtual CAM simulation, our engineers can offer guidance and support to programmers while implementing new strategies.

NC code can be supplied under certain circumstances – please ask us for more details.

## Tooling packages

Quickgrind has built an excellent reputation for providing the very best in high-performance solid carbide tools. If you are already pushing your machine to its maximum capacity, why not let Quickgrind supply you with a suite of tools to see if your tooling costs can also be reduced?

Invite us into your machine shop and allow us to demonstrate how we could improve your current processes and tooling requirements.

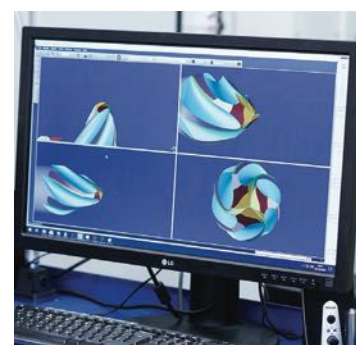



# Innovating for unlimited potential



Eliminator is an exciting range of barrel tools that takes the arc segment of a circle to form the radius of the flute, enabling improved step down strategies when compared to ballnose endmills and reducing cycle times by up to 90%.

Until now the conventional way to produce a required finish was to use a ballnose. This limits the step down, generally calculated as  $ap = 0.02 \times D1$ . For example, a 10.00mm diameter ballnose can achieve an ap of 0.20mm.

Increasing the step down would normally require a much larger diameter cutter which would not be practical – the Eliminator barrel tool does not have such limitations. The contact area is much greater because the flute radius is adapted from the segment of a much larger circle. If you wanted to increase the step down from 0.2mm to 5.0mm you would need a 250mm diameter ballnose. However, by taking a segment of a 250mm diameter circle to form the flute of your tool, and applying this to any diameter tool, you can achieve a 5.00mm step down.

Available in conical, tangential, lens and form F versions with geometries, number of flutes and dimensions to suit your individual applications, Eliminator significantly reduces finishing cycle times on deep pockets, shallow pockets with small radii, hard to reach faces, radial and tangential faces, gear cutting, blisks, vanes and moulds which would all normally require a ballnose.

The full Eliminator range is available to you now, with custom-made tools on a short delivery.

Start your cycle time  
and finishing revolution today.  
Call +44 (0) 1684 294090  
or visit [quickgrind.com](http://quickgrind.com)

**Four  
pockets  
in less  
time than  
one**

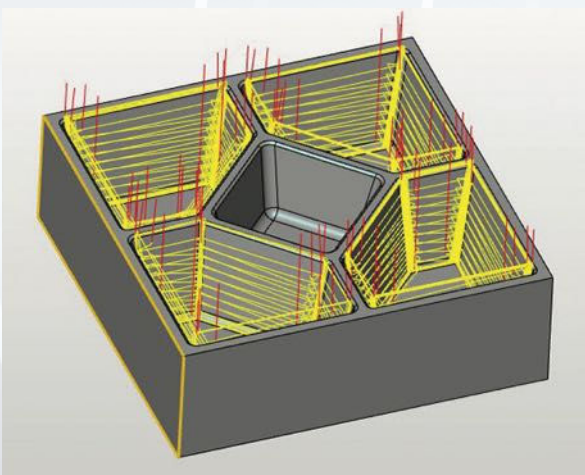

### Eliminator

12mm Ø R3 conical barrel tool with 250mm flute radius

Spindle speed – 7,958 rpm

Feedrate – 2,984 mm/min

2 minutes 11 seconds for each pocket

**4 pockets machined in 8 minutes 46 seconds**

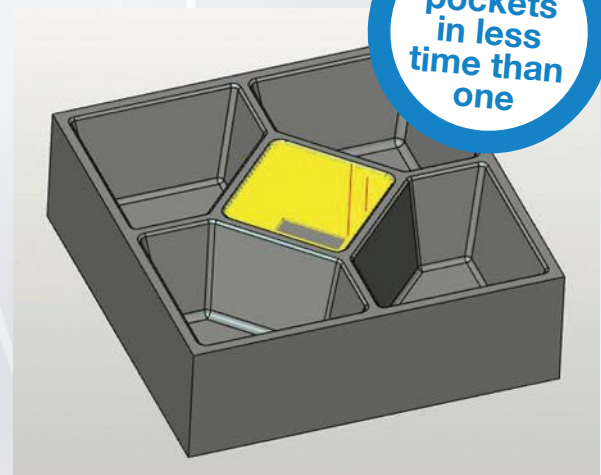

### Ballnose

6mm Ø ballnose

Spindle speed – 10,610 rpm

Feedrate – 2,122 mm/min

1 x middle pocket only

**1 pocket machined in 9 minutes 24 seconds**

# Leading the way

## in cycle time reductions



Through our association with *hyperMILL*® and CGTech VERICUT we can provide very accurate cycle time studies to show instant time savings on your projects and we work with all major tool manufacturers.

Our turnkey solutions include an NC programme with an on-site prove-out, right through to your final inspection.

You may only require an optimised toolpath for a certain area of a part. We can provide an NC programme which can be inserted into your existing programme, enhancing the performance of your machining process and ultimately allowing more parts to pass through your machine shop.

And with the new barrel tool strategies we are using we see cycle time reductions of up to 90%.

If you already have the optimised strategy for your machine why not let us re-tool your component with our extensive range of high performance solid carbide tooling.

### High feed tooling

Our Phantom, Spectre, Reaper and Bulldog range of tools are highly successful in high feed strategies. Ideal for harder, difficult materials these tools are available for numerous applications within your machining environment.

### Variable and multi-flute endmills

If you're machining titaniums, hardened alloys, stainless steels or mild steel our Mirage and Mirage Super range is extremely effective. Trochoidal milling patterns in titanium and exotics mean 2, 3 and 4xD depths of cut are readily taken.

Our range of 6 and 8 fluted Demon endmills are perfect for your roughing and finishing strategies.

### Standard and long flute lengths

The Qcut and Qplus range of tools are designed for mild steels up to 65 Rc. The Qcut has an industry standard flute length whilst the Qplus has a longer flute for a higher metal removal rate.

Whatever the situation, you can be certain that Quickgrind and QuickCam have a tool and a strategy to suit your application.



# Achieving the optimum strategy

QuickCam operation sheets give you all the data you need to achieve the optimum machining strategy. We provide you with all of the tooling information, including tool number and description, tailored to your machine, operation and material.



# Improving your machining performance

Quickgrind's state-of-the-art Technical Centre offers a comfortable and technologically advanced environment to discuss all of your cutting tool requirements, challenges and ambitions.

Our experts will work with you to conduct trials whilst generating and running tool paths and machining strategies. Our investment in the centre enables us to demonstrate what is possible with our ground-breaking tooling and tool management solutions.

The centre is fully equipped with a seminar theatre and training room, meeting rooms and machining centres. Visitors can take a guided tour of our production facility, undergo technical training and discuss their specific requirements.



Call us  
today to  
arrange  
your visit





# INFINITE POSSIBILITIES.®

What if you could have the optimum tool, with the marginal cost increase more than covered by improved production throughput and efficiency? With Quickgrind, you can. Welcome to a world of Infinite Possibilities.®

At Quickgrind we do not limit ourselves to standard ranges, and we do not limit you to tools we have in stock. Instead, our mission is to provide you with solution-based tooling, to give you the right tool, for the right job, at the right price.

Most of our cutters can be designed specifically for your application – size, diameter, neck relief, coating, reach and number of flutes can all be tailored to your needs. Through-coolant and other options are also available.

End the compromise of standard tooling. Contact our team today to discuss your applications, aims and requirements. There are no limits, only Infinite Possibilities.®

Call +44 (0) 1684 294090  
or visit [quickgrind.com](http://quickgrind.com)

## Ordering is as easy as one, two, three

### 1. Choose your shank spec

- Length • Diameter • Tolerance
- DIN or other shank standards

### 2. Choose your neck spec

- Length • Diameter

### 3. Choose your head spec

- Length • Diameter
- Tolerance • Number of flutes
- Helix angle • Anti-vibration
- Radial/axial through-coolant
- Coating



That's it. No catalogues to trawl through, no complicated product codes, no lengthy tables, just tell us what you need for your job and we will make it for you. Even specials can be designed, proved and delivered in days, at a cost you could recoup on your first job. That's Infinite Possibilities.®

**Remember, just ask** – we will make it for you

Quickgrind Limited | Unit 5701 Shannon Place | Shannon Way  
Tewkesbury | Gloucestershire | GL20 8SL | United Kingdom  
t +44 (0) 1684 294090 | e [contact@quickgrind.com](mailto:contact@quickgrind.com) | w [quickgrind.com](http://quickgrind.com)

@quickgrind

