

DOT PEEN MARKING MACHINE

e10 c153



+ ROBUST AND RELIABLE

- Base in aluminum foundry
- Mechanics and stylus assembly designed for intensive use

+ ERGONOMICS AND COMFORT

- Counter built into the column to memorize the positions
- LED lighting for visual comfort

+ SPEED AND PRECISION

- Up to 3000 parts per day
- Axis accuracy (0,02mm)

APPLICATIONS



DOT PEEN MARKING EXAMPLES



TECHNICAL & MECHANICAL FEATURES

e10 c153	
Marking window	160 x 100 mm - 6.3 in x 3.9 in
External dimensions	385 x 350 x 704 mm - 15.2 x 13.8 x 27.7 in
Weight	28 kg - 61.7 lbs
Stylus	Tungsten carbide 60 mm - 2.4 in
Column stroke	270 mm - 10.6 in max.
Machine / controller cable length	2,5 m - 6.5 ft

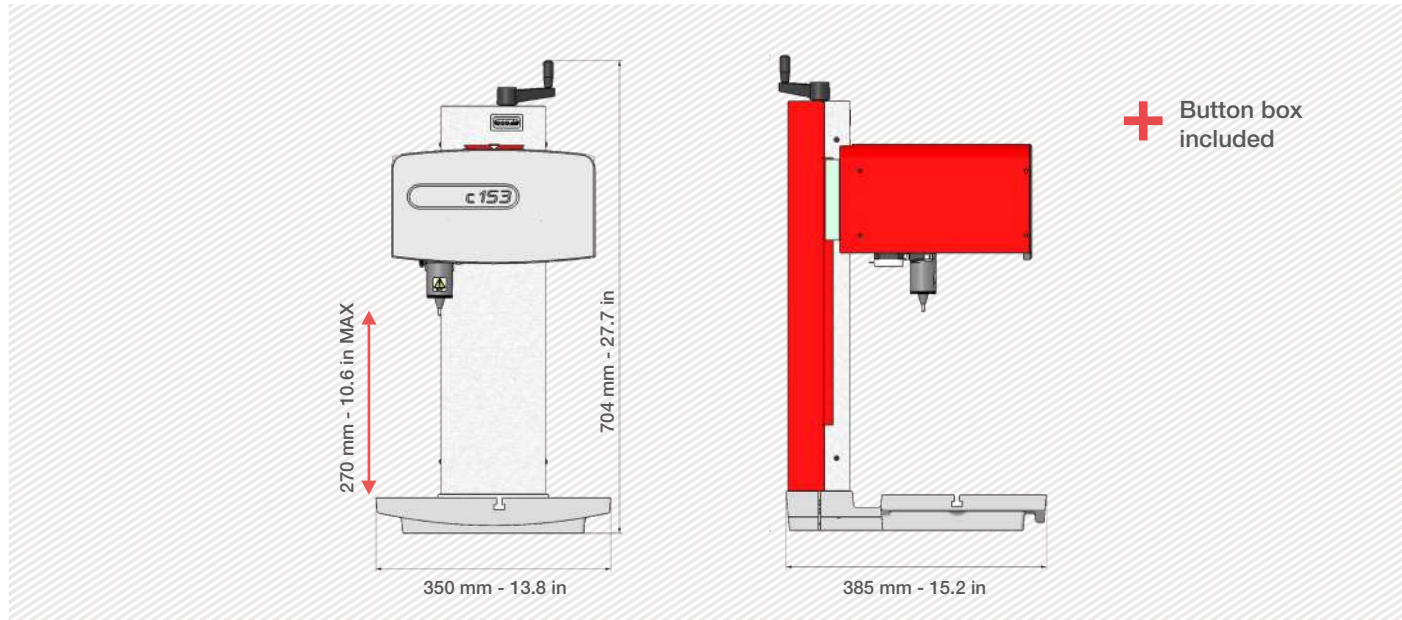

OPTIONS

			
Rotary axes	Plate support	Tag feeder	Datamatrix reader
			
Wireless barcode reader	Maintenance kit	Wide range of stylus	Starting cycle pedal

Please consult us if a specific configuration is not published in the table attached. SIC Marking designs customized and turnkey solutions for all industrial sectors. Our design offices produce machines in compliance with your specifications and your industrial standards.

E10 CONTROL UNIT

The e10 controller

- Color screen
- USB Port: to easily upload / download your marking files
- Fully programmable
- Standalone (no PC needed)
- Membrane protected industrial Keyboard
- IP40 waterproof box (no opening or fan)



+ Multiple connectivities



+ Color screen



+ USB Port



Technical & electronic features

e10 Controller	
Dimensions	322 x 380 x 112 mm - 13.7 x 15 x 4.4 in
Weight	5 kg - 11lbs
LCD screen resolution	480 x 272 pixels
Keyboard	Qwerty integrated, protected by membrane
Power	300 Watt
Power supply	Single phase, 85 to 260 VAC, 50 to 60 Hz
Controlled axes	2 (optional 3rd / 4th axis card)
Operating temperature	From 5 to 40°C

Communication	
Communication ports	RS232, RS422, USB, RS485 Profibus, TCP/IP, Ethernet/IP
Inputs-outputs	8/8
External keyboard input	USB
PC software	Creation of marking files, transfer controller / PC or USB key

Optional communication cards:

Ethernet TCP



PC UTILITIES

File editor

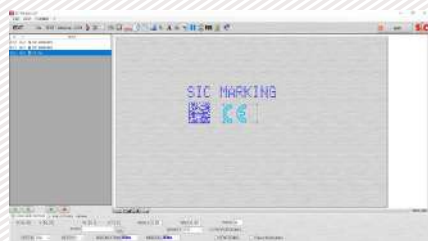

+ Creation or modification of files on PC.

Creation of logos

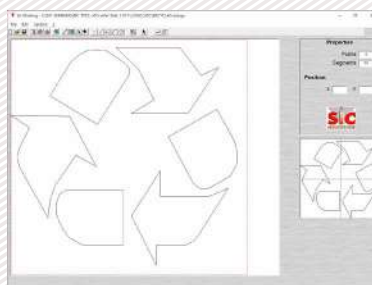

+ Creation of vector and matrix logos.

Creation of logos

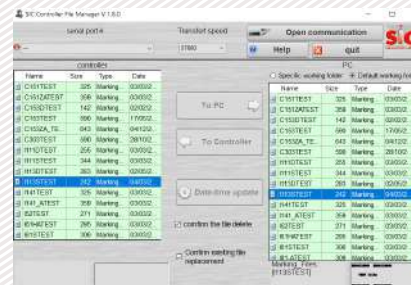

+ Backup and file transfer utility.

E 10 RANGE SOFTWARE

Software features

Text function	Incrementation, date codes
Logos	Download from a PC or USB key
Datamatrix	Up to 348 characters, 48 x 48 dots
Fonts	Arial, Comic, Comic_B, Courier, OCR, OCR_BOLD, OCRA, 4x6
Style	Angular, Radial, Inverse, and Mirror
Character Size	From 0,1 mm to 99 mm (limited following marking window)
Depth	Up to 0,3 mm (according to the material)
Resolution Between Dots	0,05 mm MAX
Password	2 security levels
History function	Exportable Excel file
Help with maintenance	Auto diagnosis
Available languages	17



Graphic view

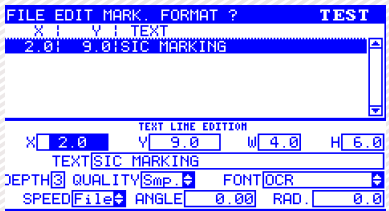

Edit menu

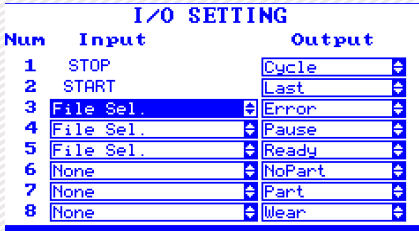

Num	Input	Output
1	STOP	Cycle
2	START	Last
3	File Sel.	Error
4	File Sel.	Pause
5	File Sel.	Ready
6	None	NoPart
7	None	Part
8	None	Wear

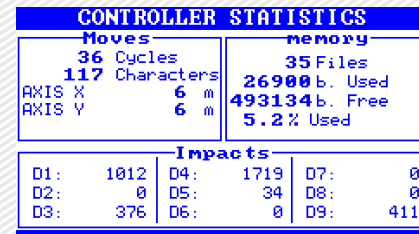

Moves		memory	
36 Cycles	117 Characters	35 Files	26900 b. Used
AXIS X 6 m	AXIS Y 6 m	493134 b. Free	5.2% Used

Impacts		
D1: 1012	D4: 1719	D7: 0
D2: 0	D5: 34	D8: 0
D3: 376	D6: 0	D9: 411

PC software for directly controlling the marking machine.

Available functions:

- Editing of marking files
- Input / output management
- History function and anti duplicates
- Datamatrix ECC200 and UID
- ...

OPTIONAL WINSIC SOFTWARE

WINSIC is a PC software for direct control of the marking machine.

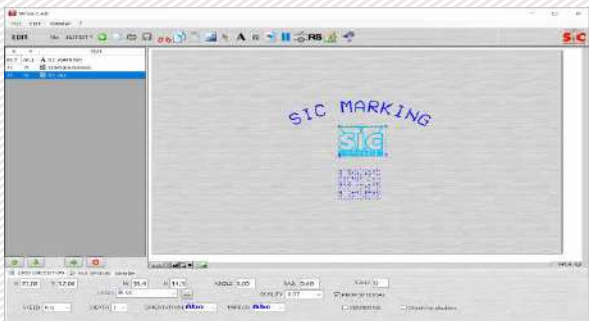

+ Built-in logo design utility

+ Database Management (Excel, Access, txt)

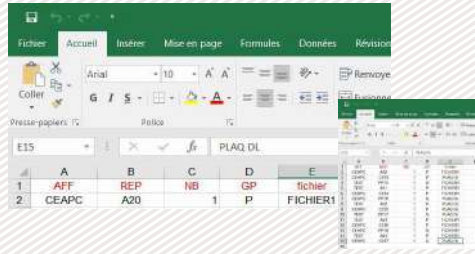

+ Insertion of background images

